

HER HAKKI MAHFIYDÜR. YAZILIZIN OLMADAN ÇOK KÖRMLERİNİÇER KESİM ÇIZIMLA, KAYIT. BİLGİ VEYA DİĞER HERHANGİ BİR ŞEKLİLE COĞAL TILANMAZ VE YATIRILMAZ.
 ALL RIGHTS RESERVED. REPRODUCTION OR ISSUE TO THIRD PARTIES IN ANY FORM WITHOUT WRITTEN PERMISSION IS NOT PERMITTED WITHOUT WRITTEN AUTHORITY FROM THE PROPRIETORS.

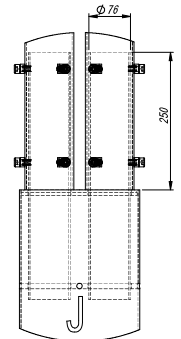

REV.	TANIM	TARİH	ONAY
REVIZYONLAR / REVISIONS	DESCRIPTION	DATE	APPROVED
GENEL NOTLAR / GENERAL NOTES			
TUTAN ÖLÇÜLER mm DİR. / ALL DIMENSIONS ARE IN mm.			
TUTAN ÇİZİM ELİMANİSİ ARZU ETİLİR. ÇİZİM VE DİZEYİMİN İÇERİSİNDE KALDIRILAN İÇERİLERİN İZİNİ ALINIR. / ALL DIMENSIONS ARE IN mm. ALL DIMENSIONS ARE IN mm. ALL DIMENSIONS ARE IN mm.			
TUTAN ÇİZİM ELİMANİSİ ARZU ETİLİR. ÇİZİM VE DİZEYİMİN İÇERİSİNDE KALDIRILAN İÇERİLERİN İZİNİ ALINIR. / ALL DIMENSIONS ARE IN mm. ALL DIMENSIONS ARE IN mm. ALL DIMENSIONS ARE IN mm.			
TUTAN ÇİZİM ELİMANİSİ ARZU ETİLİR. ÇİZİM VE DİZEYİMİN İÇERİSİNDE KALDIRILAN İÇERİLERİN İZİNİ ALINIR. / ALL DIMENSIONS ARE IN mm. ALL DIMENSIONS ARE IN mm. ALL DIMENSIONS ARE IN mm.			
ÇİZİM / DRAWING	CARSLAN		
KONTROL / CONTROL	A.BADIN		
ONAY / APPROVAL	E.COSKUN		
8M DEKO POLE OUTLINE			
İB/TEP/İB/İB	MB3252		
TEP/İB/İB/İB	MB3252		
TARİH / DATE	3/18/2020		
SÖZLEŞME / CONTRACT			
SÖZLEŞME / CONTRACT	POLİGON	ŞİFRET / CODE	ÖLÇEK / SCALE
		1:50	A2
			REV [2]

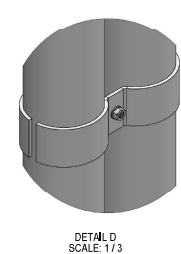
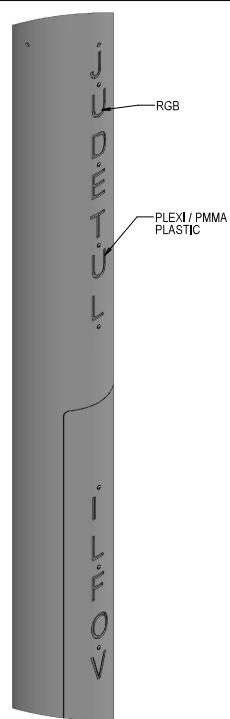
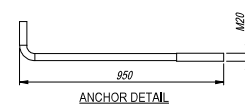
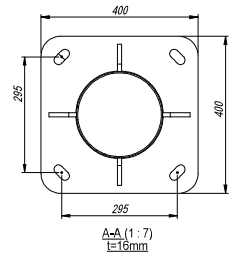
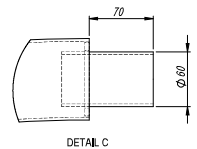
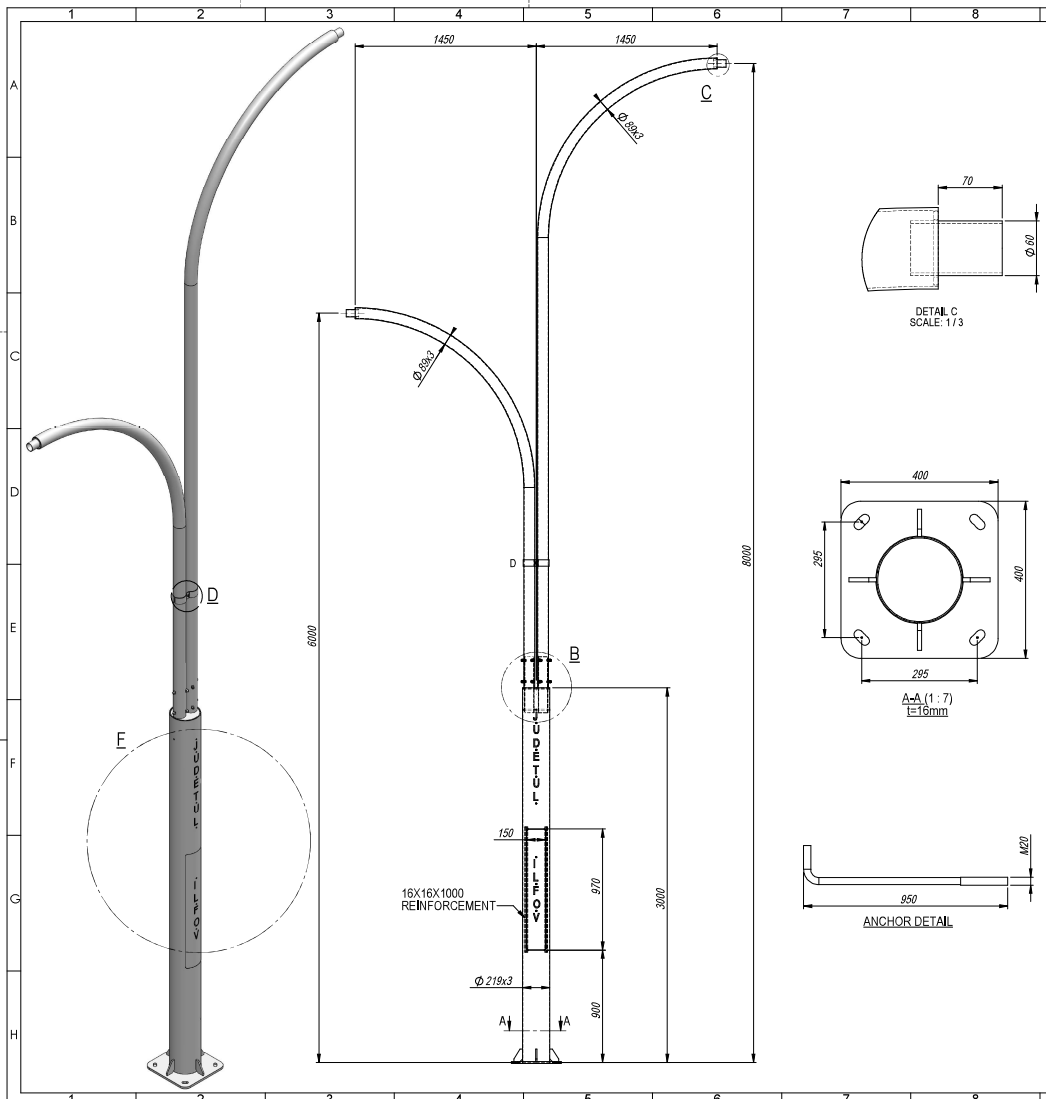