

Made in Italy

- Neva 1.0, code: NV10005SA
Linear profiles for outdoor applications

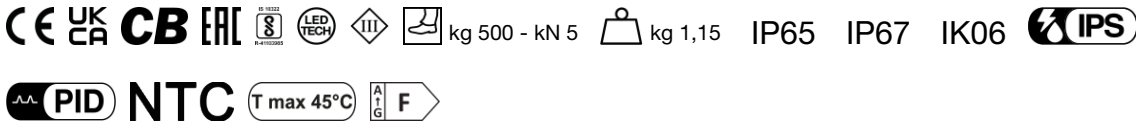

03/07/2025 Rev. 20/2024

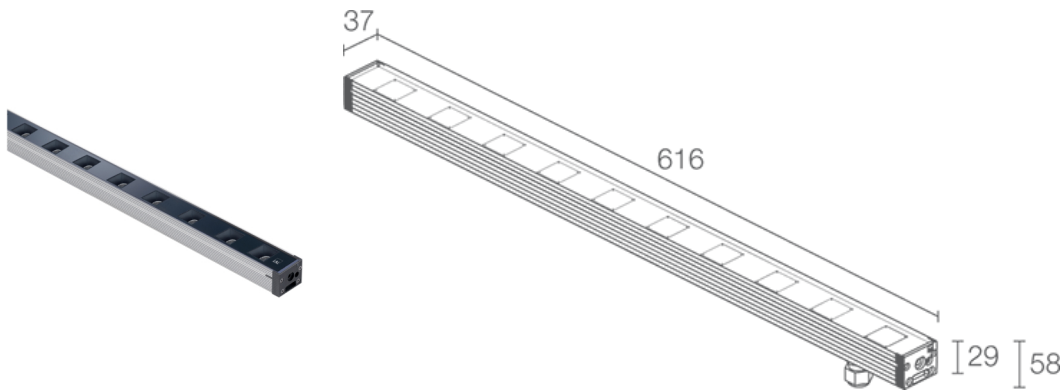

DESCRIPTION

linear profile for outdoor applications; walkover up to 500 kg; surface mounted (ceiling, wall, floor) with brackets or recessed (ceiling, floor, wall) with outer casing; Power consumption: 18W; Power supply: 24Vdc; Lumen output at source: 1392 lm (3000K, 18W); Delivered lumen output: 1150 lm (3000K, 30°, 18W); 10 power LEDs, 3-step MacAdam, 50 000h L90 B10 (Ta 25°C); LED colour: 3000K; Optics: 11°; optical system composed of a series of equidistant light sources, 60 mm apart. The deep-set TIR lens guarantees high-quality light emission and visual comfort; CRI Colour Rendering Index: 80; Body material: body made of ANTICORODAL 6060 low-copper-content aluminium alloy, made from an extruded profile, then anodized grey (20 micron) to give the product better heat dissipation and increase its resistance to corrosion. Caps made of glass-fibre-reinforced polyamide for greater resistance.; Screen material: 4-mm-thick tempered, transparent extra-clear glass, with vitrified serigraphy, to ensure chromatic uniformity of light and excellent resistance to knocks and scratches.; power supply unit not included; includes 1.5 m neoprene cable H05RN-F 2x0.75 Ø6.3 mm; Ingress protection: IP65, IP67; Impact resistance: IK06; Casambi control using the Casambi app with dedicated electronics; Protection systems: IPS (Intelligent Protection System) protects lighting fixtures from water infiltrations, which can occur if there are faulty junctions between the cables in outdoor or underwater applications. This innovation, patented by L&L, also guarantees electrical protection against polarity reversal, hot plugging, ESD and power surges, which can occur if there are faults in the electrical circuit; The PID (Protective Impedance Device) protects lighting fixtures from electrical phenomena external to the system, such as static electricity accumulation or electromagnetic interference coming from the mains power. Generally, these are events with a low energy content; This is an NTC thermistor mounted on the LED board to protect the lighting fixture against overheating. Should the product function at an operating temperature greater than the maximum temperature at which it can operate correctly, the protection is activated and gradually reduces the power. The NTC causes the integrated electronic parts to cool down to avoid the lighting fixture instantly switching itself off. When the operating temperature is again within normal range, the NTC automatically restores the lighting fixture's original operating conditions; Operating temperature: -20°C — +45°C; Maximum device temperature: 45°C (Ta 25°C); Glow wire test: 960°C; Photobiological safety: in accordance with IEC TR 62778:2014; Appliance class: class III; Weight: 1150 g; Dimensions: 616x37x29mm; Energy efficiency class: F (light source) in accordance with EU 2019/2015; Accessories: WB6510 Anti-glare shield in black-painted stainless steel - 612 mm, WC6510 Aluminium outer casing - 622 mm, WC6710 Aluminium outer casing for plasterboard - 622 mm, WH6010 Honeycomb louvre, WM0601 Pair of brackets h 75 mm, WM0602 Pair of brackets h 140 mm, WN6001 Anti-fall kit, WN6002 U-shaped brackets pair, WN6003 Springs pair, WN6005 Alignment kit for outer casing, WN6006 Pair of extractors for outer casings; tested and approved via E.O.L. (End Of Line) test with functioning test and check of electrical power consumption

Status: Available

ELECTRICAL CHARACTERISTICS

Power consumption	18W
Power supply	24Vdc
Power supply unit	power supply unit not included

LIGHTING CHARACTERISTICS

Number and type of LED	10 power LEDs
Average LED life	50 000h L90 B10 (Ta 25°C)
LED colour	3000K
CRI Colour Rendering Index	80
Binning	3-step MacAdam
Optics	11°
Lumen output at source	1392 lm (3000K, 18W)
Delivered lumen output	1150 lm (3000K, 30°, 18W)

MECHANICAL CHARACTERISTICS

Dimensions	616x37x29mm
Weight	1150 g
Mounting	with adjustable brackets and screws or with outer casing
Body material	body in anodized anticorodal aluminium
Screen material	screen in serigraphed, transparent, tempered extra-clear glass

GENERAL CHARACTERISTICS

Ingress protection	IP65, IP67
Operating temperature	-20°C – +45°C
Impact resistance	IK06
Energy efficiency class	F (light source) in accordance with EU 2019/2015
Glow wire test	960°C
Maximum device temperature	45°C (Ta 25°C)
Appliance class	class III
Drive-over	no
Walkover	up to 500 kg
Power cables	includes 1.5 m neoprene cable H05RN-F 2x0.75 Ø6.3 mm
Protection systems	IPS (Intelligent Protection System); PID (Protective Impedance Device); NTC (thermistor mounted on LED board)
Photobiological safety	in accordance with IEC TR 62778:2014
Notes	Casambi control using the Casambi app with dedicated electronics

PHOTOMETRIC DATA

S - 11°

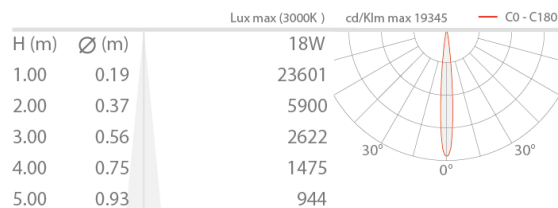

ACCESSORIES

Installation Accessories



WC6510
Aluminium outer casing - 622 mm



WC6710
Aluminium outer casing for plasterboard - 622 mm

Anti-glare



WB6510
Anti-glare shield in black-painted stainless steel - 612 mm

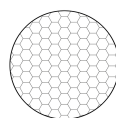

WH6010
Honeycomb louvre
built into the lighting fixture
Order together with the lighting fixture

Other



WM0601
Pair of brackets h 75 mm



WM0602
Pair of brackets h 140 mm

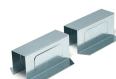

WN6001
Anti-fall kit



WN6002
U-shaped brackets pair



WN6003
Springs pair



WN6005
Alignment kit for outer casing

WN6006
Pair of extractors for outer casings

L&L Luce&Light SRL reserves the right to change the information contained in this document at any time without prior notice being given.