

LED continuous-row luminaire

Linear, energy-efficient TECTON LED continuous-row luminaire with 64 highly efficient mid-power LEDs per segment. Luminaire input power: 21.8 W, DALI controllable luminaire with LED converter, makes environmental and financial sense. LED service life lasts 100000 h before luminous flux is reduced to 95% of the initial value. Chromaticity tolerance (initial MacAdam): 2. Luminaire efficacy: 174 lm/W. Luminaire luminous flux: 3790 lm. Luminaire with symmetric narrow light distribution (narrow beam). Colour rendering Ra > 80, colour temperature 4000 K. Split lens concept for reducing perceived glare. Overlapping PMMA lenses (shatter-resistant to IK07) achieve IP50 protection for LED and optic. All-in-one solution: lighting batten, lamp and reflector are combined in one product to produce a 100 % continuous ribbon of LED light without gaps. High-quality look in a design that matches the trunking. Dimming level for DC mode preset to 15 %. LED continuous-row luminaire of sheet steel, enamelled in polyester lacquer finish, white. 100% flexible, tool-free mechanical and electrical installation using CLIX-technology by means of two side-mounted rotary levers on the TECTON trunking. No ultraviolet or infrared radiation. Ambient temperature: -20°C to +40°C. Luminaire wired with halogen-free leads, silicone-free. Note: please talk to your adviser if you are planning to use the luminaire in environments containing chemical pollutants. Dimensions: 1000 x 60 x 85 mm. Weight: 1.5 kg.

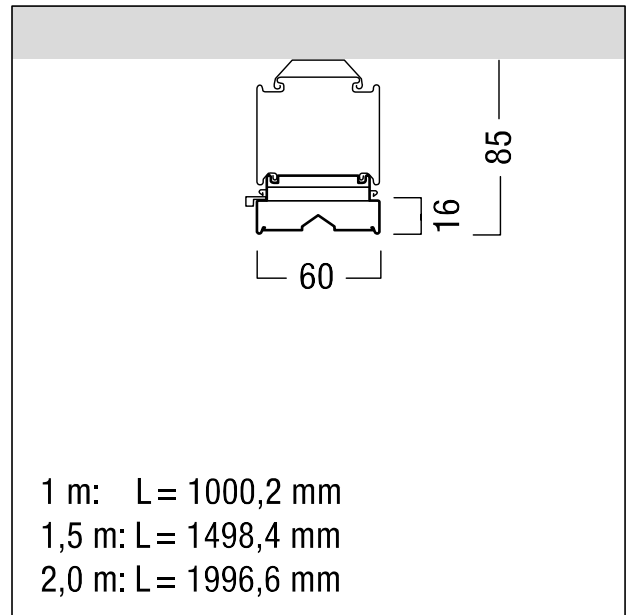

ZS_TEC_F_LED_Balken.jpg



ZS_TEC_M_C_LED_Balken.wmf

Light Distribution

STD - standard

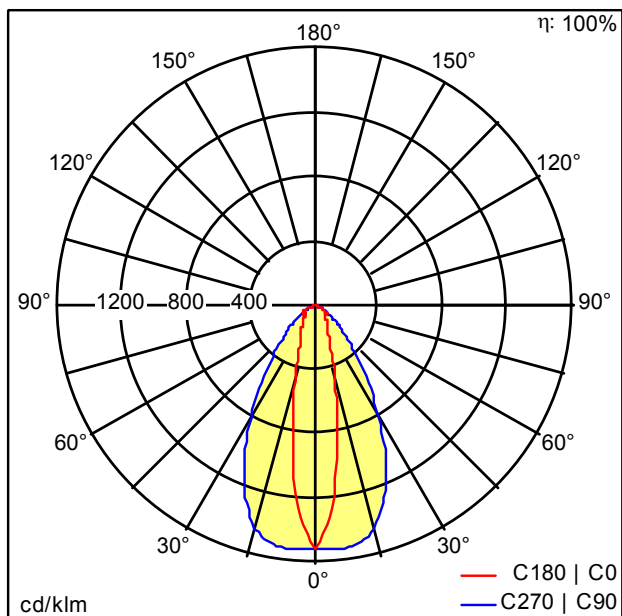

D43653AA_TECTON_C_LED3700-840_L1000_NB_LDE_WH.Idt

- Light Source: LED
- Luminaire luminous flux*: 3790 lm
- Luminaire efficacy*: 174 lm/W
- Colour Rendering Index min.: 80
- Ballast: 1 x 28000655 DRV TR LCA 50W 400mA 140V D #O4A Ip PRE
- Correlated colour temperature: 4000 Kelvin
- Chromaticity tolerance (initial MacAdam): 2
- Rated median useful life*:
L95 100000h at -20°C
L95 100000h at 40°C
- Luminaire input power*: 21.8 W Power factor = 0.9
- Standby Power*: 0.15 W
- Dimming: LDE dimmable to 1%
over DALI, DSI and switchDIM
DC level is adjustable
- Maintenance category: D - Enclosed IP2X

Please also consult the additional information on the next page

TECTON LED continuous-row luminaire



ZUMTOBEL

TECTON C LED3700-840 L1000 NB LDE WH

42183294

LED continuous-row luminaire

All values marked with an * are rated values. Luminous flux and connected electrical load are subject to an initial tolerance of +/- 10%. Unless stated otherwise, the values apply to an ambient temperature of 25°C.

The level of luminous flux reduces over the life cycle due to technological reasons. The failure of up to 2 LED points causes no functional impairment and is therefore no reason for complaint.

The failure of a complete lens cell causes reason for complaint

We reserve the right to make technical changes without prior notice. 22.11.2021 © Zumtobel - 5-year guarantee in compliance with the terms of guarantee at www.zumtobel.com/guarantee