

Tracks/channels

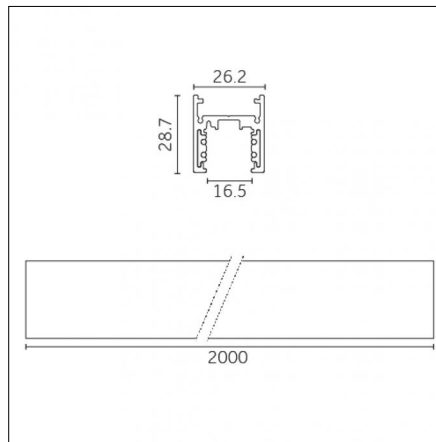
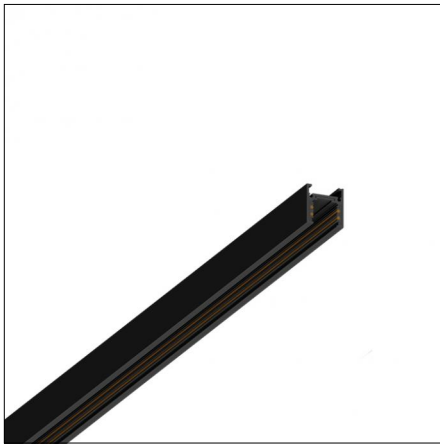

Code 0.02456.0031

Physical features

Finishing: Embossed matte black

Length: 2000mm

Weight: 1.4Kg

Description: Accessories: drivers to be ordered separately

For installations with Yori Evo 48V and Yori Pendant 48V with dimmer on board, use P.31656.0000 DRIVER 48Vdc or P.31650.0000 DRIVER 48Vdc 150W.

Luminaire constructed in conformity with Directives 2014/35/EU (LV), 2014/30/EU (EMC), 2009/125/EC (Ecodesign) with Regulations (EC) No 245/2009, (EU) No 347/2010 and (EU) 2015/1428 (for luminaires with fluorescent and metal halide lamps only), 2009/125/EC (Ecodesign) with Regulations (EU) No 1194/2012 and 2015/1428 (for LED luminaires only), 2011/65/EU (RoHS 2) and 2012/19/EU (WEEE).

Reggiani Lighting Srl
Viale Monza, 16 20845 Sovico (MB) Italy
Tel. (+39) 039 2071.1 fax (+39) 039 2071 999

www.reggiani.net
contact@reggiani.net

Tracks/channels

Driver

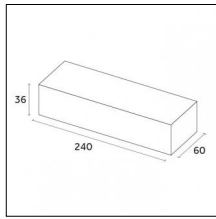

Code 0.31655.0000 - Driver

Type: On-Off

Watt: 50W - AC Input: 220-240VaC - mA:mA

Description: For more details, see the driver datasheet.

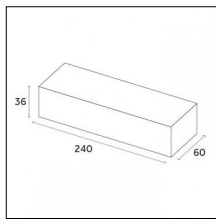

Code 0.31656.0000 - Driver

Type: On-Off

Watt: 100W - AC Input: 220-240VaC - mA:mA

Description: For more details, see the driver datasheet.

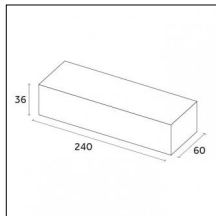

Code 0.31650.0000 - Driver

Type: On-Off

Watt: 150W - AC Input: 220-240VaC - mA:mA

Description: For more details, see the driver datasheet.



Code 0.31657.0000 - Driver

Type: On-Off

Watt: 250W - AC Input: - mA:mA

Description: For more details, see the driver datasheet.

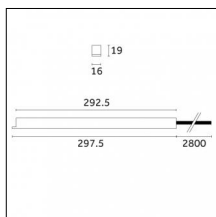

Code 0.30550.0000 - In-Track Driver

Type: On-Off

Watt: 100W - AC Input: 220-240VaC - mA:mA

Description: For more details, see the driver datasheet.

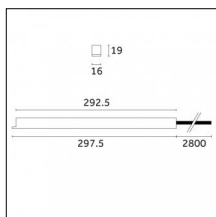

Code D.30550.0000 - In-Track Driver

Type: DALI

Watt: 100W - AC Input: 220-240VaC - mA:mA

Description: For more details, see the driver datasheet.

Luminaire constructed in conformity with Directives 2014/35/EU (LV), 2014/30/EU (EMC), 2009/125/EC (Ecodesign) with Regulations (EC) No 245/2009, (EU) No 347/2010 and (EU) 2015/1428 (for luminaires with fluorescent and metal halide lamps only), 2009/125/EC (Ecodesign) with Regulations (EU) No 1194/2012 and 2015/1428 (for LED luminaires only), 2011/65/EU (RoHS 2) and 2012/19/EU (WEEE).

Tracks/channels

Accessories

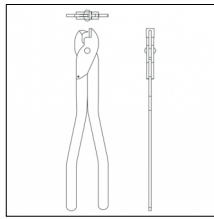

Code 0.02064.0000 - Cutting tool for track conductors

Type: Mounting
Finishing: Without finish / Natural aluminium

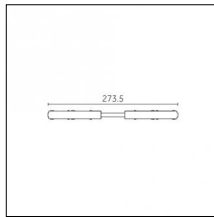

Code 0.02404.0010 - Flexible feeding connector for 90° corner

Type: Electrical
Finishing: White

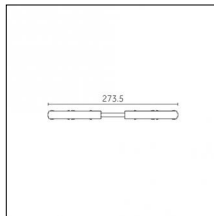

Code 0.02404.0021 - Flexible feeding connector for 90° corner

Type: Electrical
Finishing: Black

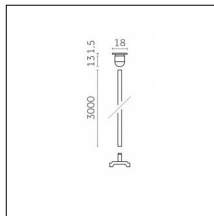

Code 0.02407.0000 - Wire suspension set with 3000mm cable

Type: Structural
Finishing: Without finish / Natural aluminium
Description: Cylinder ceiling rose, short bracket with gripper for rapid cable Ø1,5mm installation

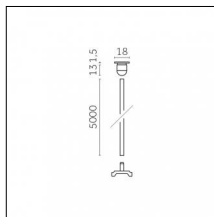

Code 0.02408.0000 - Wire suspension set with 5000mm cable

Type: Structural
Finishing: Without finish / Natural aluminium
Description: Cylinder ceiling rose, long bracket with gripper for rapid cable Ø1,5m installation

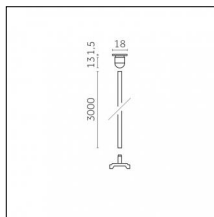

Code 0.02409.0000 - Wire suspension set with 3000mm cable

Type: Structural
Finishing: Without finish / Natural aluminium
Description: Cylinder ceiling rose, long bracket with gripper for rapid cable Ø1,5m installation

Luminaire constructed in conformity with Directives 2014/35/EU (LV), 2014/30/EU (EMC), 2009/125/EC (Ecodesign) with Regulations (EC) No 245/2009, (EU) No 347/2010 and (EU) 2015/1428 (for luminaires with fluorescent and metal halide lamps only), 2009/125/EC (Ecodesign) with Regulations (EU) No 1194/2012 and 2015/1428 (for LED luminaires only), 2011/65/EU (RoHS 2) and 2012/19/EU (WEEE).

Tracks/channels

Accessories

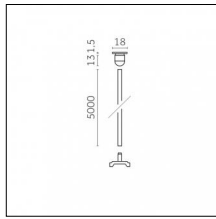

Code 0.02410.0000 - Wire suspension set with 5000mm cable

Type: Structural

Finishing: Without finish / Natural aluminium

Description: Cylinder ceiling rose, long bracket with gripper for rapid cable Ø1,5m installation

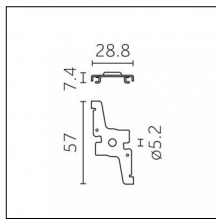

Code 0.02415.0010 - Bracket for surface-mounting

Type: Mounting

Finishing: White

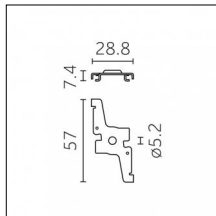

Code 0.02415.0021 - Bracket for surface-mounting

Type: Mounting

Finishing: Black

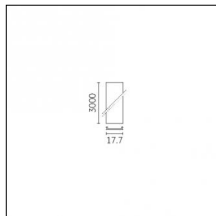

Code 0.02425.0010 - 48V track cover

Type: Structural

Finishing: White

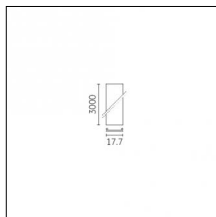

Code 0.02425.0021 - 48V track cover

Type: Structural

Finishing: Black

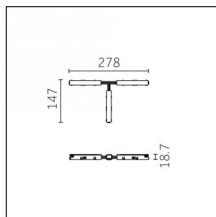

Code 0.02427.0010 - T joint

Type: Electrical

Finishing: White

Luminaire constructed in conformity with Directives 2014/35/EU (LV), 2014/30/EU (EMC), 2009/125/EC (Ecodesign) with Regulations (EC) No 245/2009, (EU) No 347/2010 and (EU) 2015/1428 (for luminaires with fluorescent and metal halide lamps only), 2009/125/EC (Ecodesign) with Regulations (EU) No 1194/2012 and 2015/1428 (for LED luminaires only), 2011/65/EU (RoHS 2) and 2012/19/EU (WEEE).

Tracks/channels

Accessories

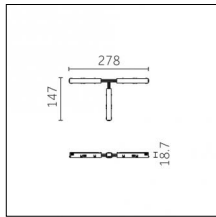

Code 0.02427.0021 - T joint

Type: Electrical
Finishing: Black

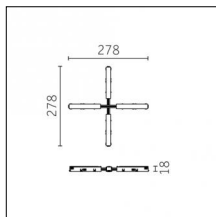
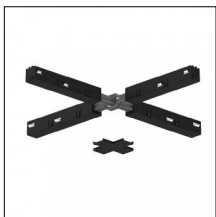

Code 0.02428.0010 - X joint

Type: Electrical
Finishing: White

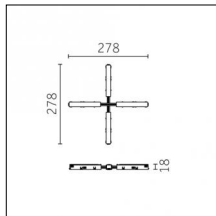
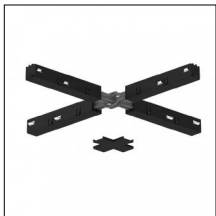

Code 0.02428.0021 - X joint

Type: Electrical
Finishing: Black

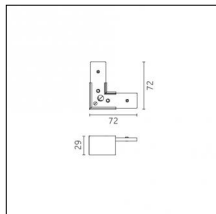

Code 0.02449.0012 - 90° corner

Type: Structural
Finishing: Embossed matte white

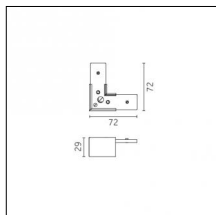

Code 0.02449.0031 - 90° corner

Type: Structural
Finishing: Embossed matte black

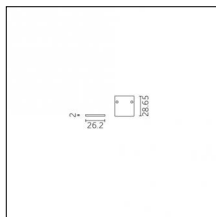
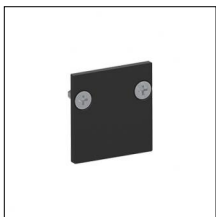

Code 0.02458.0012 - End cap

Type: Structural
Finishing: Embossed matte white

Luminaire constructed in conformity with Directives 2014/35/EU (LV), 2014/30/EU (EMC), 2009/125/EC (Ecodesign) with Regulations (EC) No 245/2009, (EU) No 347/2010 and (EU) 2015/1428 (for luminaires with fluorescent and metal halide lamps only), 2009/125/EC (Ecodesign) with Regulations (EU) No 1194/2012 and 2015/1428 (for LED luminaires only), 2011/65/EU (RoHS 2) and 2012/19/EU (WEEE).

Tracks/channels

Accessories

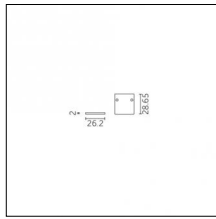
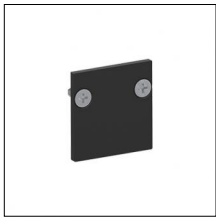

Code 0.02458.0031 - End cap

Type: Structural
Finishing: Embossed matte black

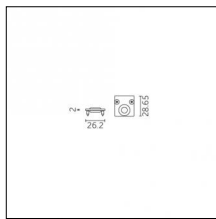

Code 0.02459.0012 - End cap with cable hole

Type: Structural
Finishing: Embossed matte white

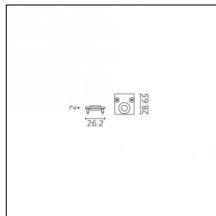
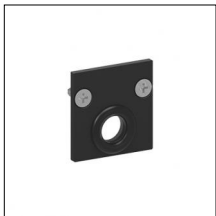

Code 0.02459.0031 - End cap with cable hole

Type: Structural
Finishing: Embossed matte black

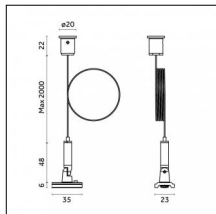

Code 0.02473.0010 - Suspension kit with 2-m long wire and counter-balance system

Type: Mounting
Finishing: White

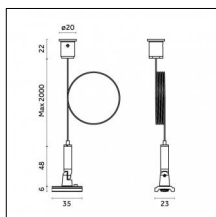

Code 0.02473.0021 - Suspension kit with 2-m long wire and counter-balance system

Type: Mounting
Finishing: Black

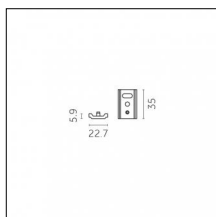

Code 0.02479.0000 - Short bracket for suspension

Type: Structural
Finishing: Without finish / Natural aluminium

Luminaire constructed in conformity with Directives 2014/35/EU (LV), 2014/30/EU (EMC), 2009/125/EC (Ecodesign) with Regulations (EC) No 245/2009, (EU) No 347/2010 and (EU) 2015/1428 (for luminaires with fluorescent and metal halide lamps only), 2009/125/EC (Ecodesign) with Regulations (EU) No 1194/2012 and 2015/1428 (for LED luminaires only), 2011/65/EU (RoHS 2) and 2012/19/EU (WEEE).

Tracks/channels

Accessories

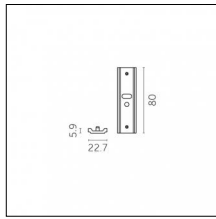

Code 0.02482.0000 - Long bracket for suspension

Type: Structural

Finishing: Without finish / Natural aluminium

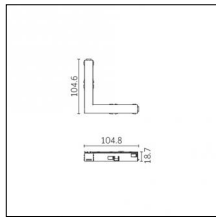

Code 0.02484.0010 - Feeding connector for 90° corner

Type: Electrical

Finishing: White

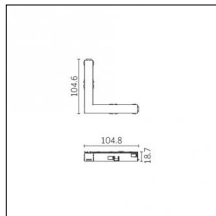
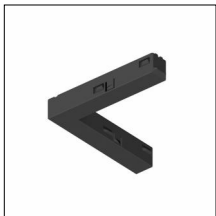

Code 0.02484.0021 - Feeding connector for 90° corner

Type: Electrical

Finishing: Black

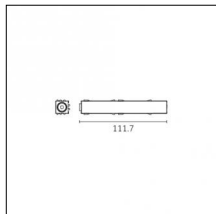

Code 0.02485.0010 - End feed

Type: Electrical

Finishing: White

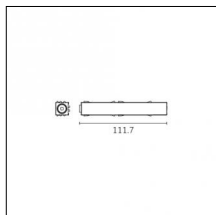

Code 0.02485.0021 - End feed

Type: Electrical

Finishing: Black

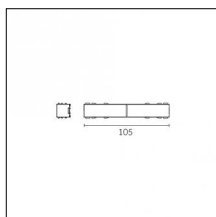

Code 0.02486.0010 - Straight feeding connector

Type: Electrical

Finishing: White

Luminaire constructed in conformity with Directives 2014/35/EU (LV), 2014/30/EU (EMC), 2009/125/EC (Ecodesign) with Regulations (EC) No 245/2009, (EU) No 347/2010 and (EU) 2015/1428 (for luminaires with fluorescent and metal halide lamps only), 2009/125/EC (Ecodesign) with Regulations (EU) No 1194/2012 and 2015/1428 (for LED luminaires only), 2011/65/EU (RoHS 2) and 2012/19/EU (WEEE).

Tracks/channels

Accessories

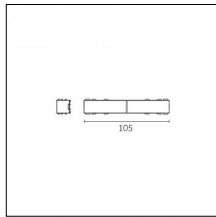

Code 0.02486.0021 - Straight feeding connector

Type: Electrical
Finishing: Black

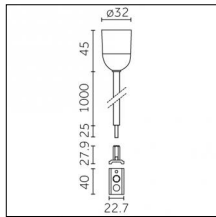
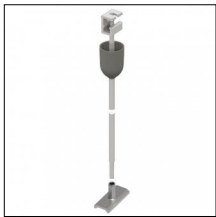

Code 0.02488.0010 - Tige for track

Type: Structural
Finishing: White

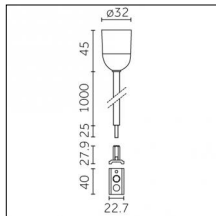

Code 0.02488.0021 - Tige for track

Type: Structural
Finishing: Black

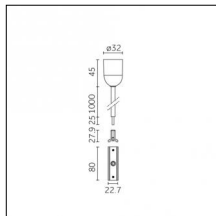

Code 0.02520.0010 - Suspension kit with 1m tige

Type: Structural
Finishing: White

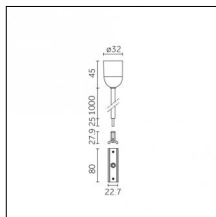

Code 0.02520.0021 - Suspension kit with 1m tige

Type: Structural
Finishing: Black

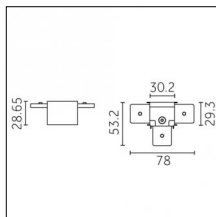

Code 0.02563.0012 - Mechanical T-joint

Finishing: Embossed matte white

Luminaire constructed in conformity with Directives 2014/35/EU (LV), 2014/30/EU (EMC), 2009/125/EC (Ecodesign) with Regulations (EC) No 245/2009, (EU) No 347/2010 and (EU) 2015/1428 (for luminaires with fluorescent and metal halide lamps only), 2009/125/EC (Ecodesign) with Regulations (EU) No 1194/2012 and 2015/1428 (for LED luminaires only), 2011/65/EU (RoHS 2) and 2012/19/EU (WEEE).

Tracks/channels

Accessories

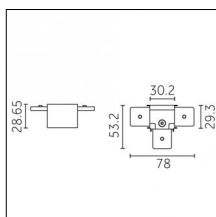
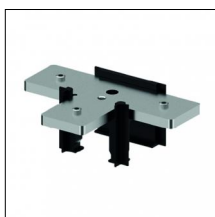

Code 0.02563.0031 - Mechanical T-joint

Finishing: Embossed matte black

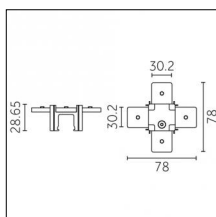
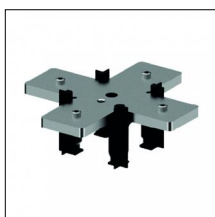

Code 0.02564.0012 - Mechanical X-joint

Finishing: Embossed matte white

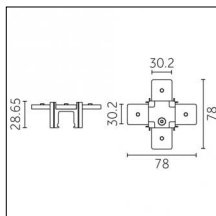
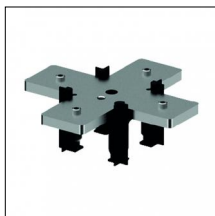

Code 0.02564.0031 - Mechanical X-joint

Finishing: Embossed matte black