

Indoor | Track mounted luminaires | Yori Evo Box

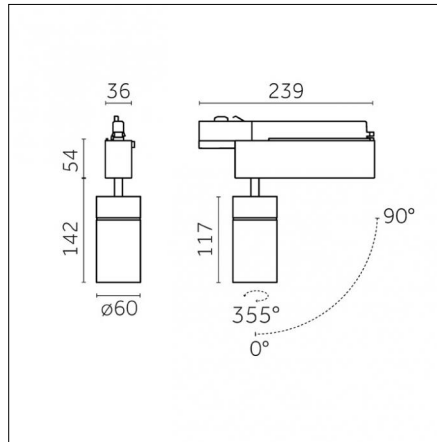
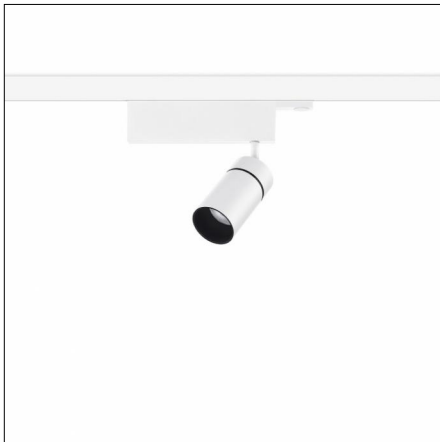

Very narrow 8°

12

IP20



Risk 1

850°



Code P.RH82A.HQ12

Light source features

Number of light sources: 1

Source type: LED HQ

Watt: 9W

Lm: 730lm

Lm/W: 81lm/W

Kelvin/CRI: 3000K / >90

SDCM/L90 B10: < 3 / 50000

Fixture total output: 599 lm

Fixture efficacy: 64 lm/W

Imax: 21085 cd

Electrical features

Driver included: YES

Driver position: integrated

Driver type: Dimmer on board 220/240 Vac 50/60 Hz

Total power consumption (LED + DRIVER): 11

Isolation class: Class II

Optical features

Beam angle: 8°

Optical type, adjustability: Adjustable

Interchangeable optic (IOS): YES

Physical features

Material: Die-cast aluminum

Mounting: Track

Fixing: Ceiling

Adjustability: 356° horizontal axis 90° vertical axis

Finishing: Embossed matt white (Standard)

Notes:

Dimm 1-10V version on request

Luminaire constructed in conformity with Directives 2014/35/EU (LV), 2014/30/EU (EMC), 2009/125/EC (Ecodesign) with Regulations (EC) No 245/2009, (EU) No 347/2010 and (EU) 2015/1428 (for luminaires with fluorescent and metal halide lamps only), 2009/125/EC (Ecodesign) with Regulations (EU) No 1194/2012 and 2015/1428 (for LED luminaires only), 2011/65/EU (RoHS 2) and 2012/19/EU (WEEE).

Reggiani SPA Illuminazione

Viale Monza, 16 20845 Sovico (MB) Italy
Tel. (+39) 039 2071.1 fax (+39) 039 2071 999

www.reggiani.net
contact@reggiani.net

Photometries

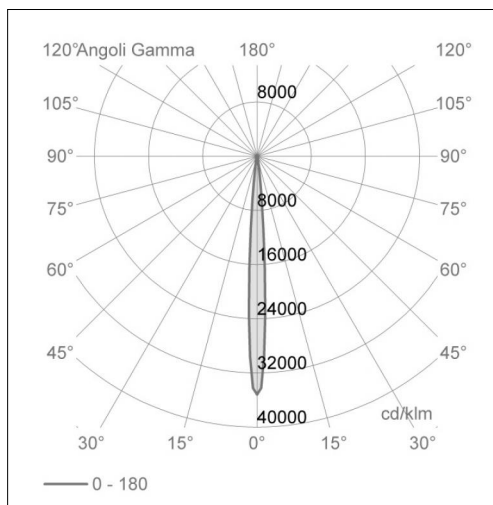
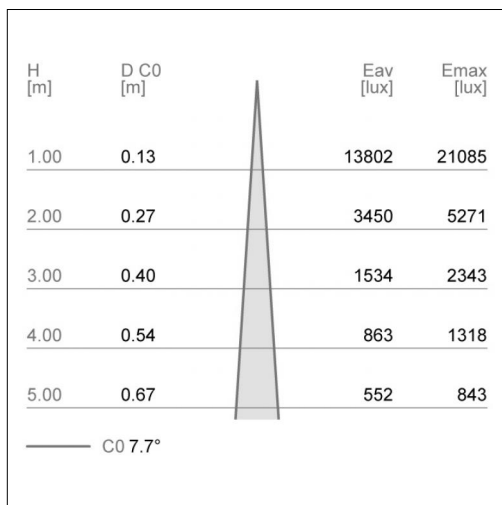

P_RH82A_HQ_12.ies
P_RH82A_HQ_12.LDT

Specifications text

Adjustable track-mounted luminaire. Symmetric light distribution. Available for LEDs. Die-cast aluminium body. From 4 W to 37 W, from 200 lm (Ø 43mm + 4 W version) to 4000 lm (Ø 95mm + 37 W version). Luminaire efficacy up to 110 lm/W; maximum intensity incandela up to 64,000 cd. Performance system of reflectors and interchangeable Precision lenses for the 60 mm, 75 mm and 95 mm sizes; Performance system of reflectors and fixed Precision lenses for the 43 mm size. Performance reflectors in 99% pure aluminium, with surface treatment; LOR of up to 90% and anti-reflective safety glass with highlight transmission (99%). Precision lenses with LOR of up to 89%, intemperature resistant PMMA (stabilised up to 140°C), V0 self-extinguishing. The spot is adjustable from 0° to 90° in the vertical axis and 356° in the horizontal axis; plastic anti-glare ring retracted optics for utmost visual comfort. The following accessories can be used with this product: cross-blade louvre, anti-glare honeycomb louvre with wide grid, anti-glare honeycomb louvre with narrow grid, diffusing lens, opal lens, ribbed lens for oval light distribution, coloured dichroic filters, selective filters, anti-glare barndoors and wall-washer shield. UV-stabilised, anti-yellowing epoxy powder coating. Available finishes: embossed matt white 12, embossed matt black 31. Passive heat dissipation is obtained through improved design of the luminaire body that exploits the thermal conductivity of the metal and the convection current. Available with standard LED On/Off driver, Phase-Cut, Dimmer On Board, DALI and DALI+Bluetooth 220/240V Vac 50/60 Hz, Dimmable Driver 1-10 V available on request. LED electronic drivers. The driver is supplied with the luminaire. Protection class I. IP20. Emergency pack (3 h) available as accessory. Luminaire constructed in conformity with standard EN 60598-1 and 2, and with ECDirectives: 2006/95/EC (LV), 2004/108/EC (EMC), 2009/125/EC (Ecodesign), 2002/96/EC (WEEE) and 2011/65/EC (RoHS).

Luminaire constructed in conformity with Directives 2014/35/EU (LV), 2014/30/EU (EMC), 2009/125/EC (Ecodesign) with Regulations (EC) No 245/2009, (EU) No 347/2010 and (EU) 2015/1428 (for luminaires with fluorescent and metal halide lamps only), 2009/125/EC (Ecodesign) with Regulations (EU) No 1194/2012 and 2015/1428 (for LED luminaires only), 2011/65/EU (RoHS 2) and 2012/19/EU (WEEE).

Tracks/channels

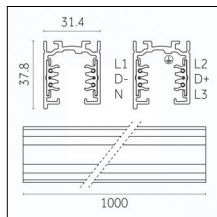

Code 0.02030.0010 - 3-circuit track surface/pendant

Finishing: White (Standard)
Length: 1000mm Width: 31.4mm Height: 37.8mm

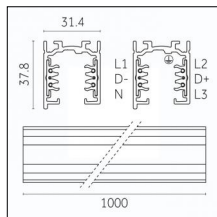

Code 0.02030.0021 - 3-circuit track surface/pendant

Finishing: Black (Standard)
Length: 1000mm Width: 31.4mm Height: 37.8mm

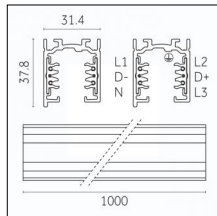

Code 0.02030.0028 - 3-circuit track surface/pendant

Finishing: Metallised grey (Standard)
Length: 1000mm Width: 31.4mm Height: 37.8mm

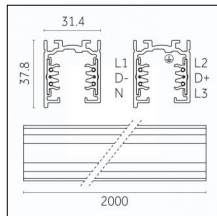

Code 0.02031.0010 - 3-circuit track surface/pendant

Finishing: White (Standard)
Length: 2000mm Width: 31.4mm Height: 37.8mm

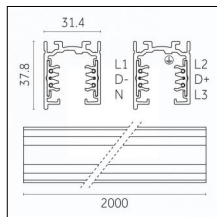

Code 0.02031.0021 - 3-circuit track surface/pendant

Finishing: Black (Standard)
Length: 2000mm Width: 31.4mm Height: 37.8mm

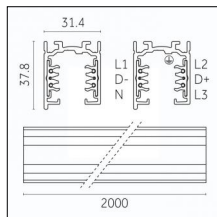

Code 0.02031.0028 - 3-circuit track surface/pendant

Finishing: Metallised grey (Standard)
Length: 2000mm Width: 31.4mm Height: 37.8mm

Luminaire constructed in conformity with Directives 2014/35/EU (LV), 2014/30/EU (EMC), 2009/125/EC (Ecodesign) with Regulations (EC) No 245/2009, (EU) No 347/2010 and (EU) 2015/1428 (for luminaires with fluorescent and metal halide lamps only), 2009/125/EC (Ecodesign) with Regulations (EU) No 1194/2012 and 2015/1428 (for LED luminaires only), 2011/65/EU (RoHS 2) and 2012/19/EU (WEEE).

Tracks/channels

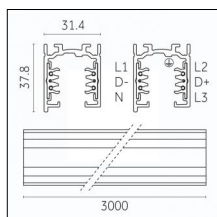

Code 0.02032.0010 - 3-circuit track surface/pendant

Finishing: White (Standard)
Length: 3000mm Width: 31.4mm Height: 37.8mm

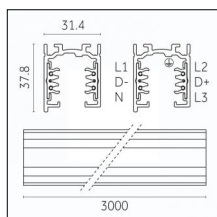

Code 0.02032.0021 - 3-circuit track surface/pendant

Finishing: Black (Standard)
Length: 3000mm Width: 31.4mm Height: 37.8mm

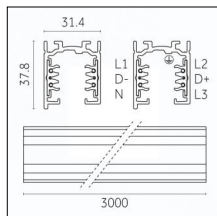

Code 0.02032.0028 - 3-circuit track surface/pendant

Finishing: Metallised grey (Standard)
Length: 3000mm Width: 31.4mm Height: 37.8mm

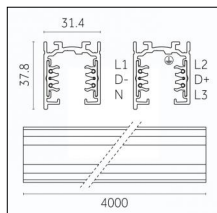

Code 0.02033.0010 - 3-circuit track surface/pendant

Finishing: White (Standard)
Length: 4000mm Width: 31.4mm Height: 37.8mm

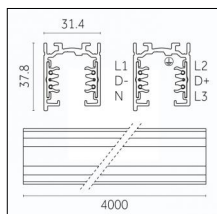
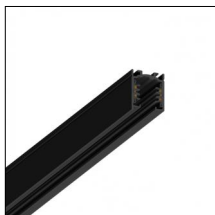

Code 0.02033.0021 - 3-circuit track surface/pendant

Finishing: Black (Standard)
Length: 4000mm Width: 31.4mm Height: 37.8mm

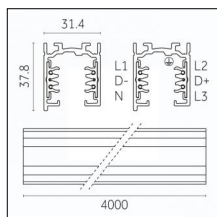

Code 0.02033.0028 - 3-circuit track surface/pendant

Finishing: Metallised grey (Standard)
Length: 4000mm Width: 31.4mm Height: 37.8mm

Luminaire constructed in conformity with Directives 2014/35/EU (LV), 2014/30/EU (EMC), 2009/125/EC (Ecodesign) with Regulations (EC) No 245/2009, (EU) No 347/2010 and (EU) 2015/1428 (for luminaires with fluorescent and metal halide lamps only), 2009/125/EC (Ecodesign) with Regulations (EU) No 1194/2012 and 2015/1428 (for LED luminaires only), 2011/65/EU (RoHS 2) and 2012/19/EU (WEEE).

Tracks/channels

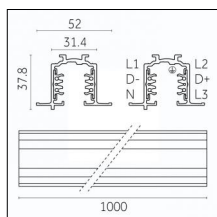

Code 0.02034.0010 - 3-circuit track recessed

Finishing: White (Standard)
Length: 1000mm Width: 52mm Height: 37.8mm

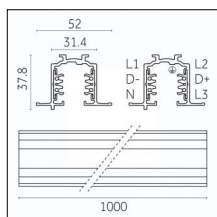

Code 0.02034.0021 - 3-circuit track recessed

Finishing: Black (Standard)
Length: 1000mm Width: 52mm Height: 37.8mm

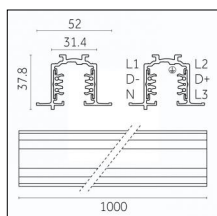

Code 0.02034.0028 - 3-circuit track recessed

Finishing: Metallised grey (Standard)
Length: 1000mm Width: 52mm Height: 37.8mm

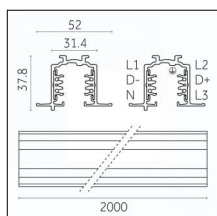

Code 0.02035.0010 - 3-circuit track recessed

Finishing: White (Standard)
Length: 2000mm Width: 52mm Height: 37.8mm

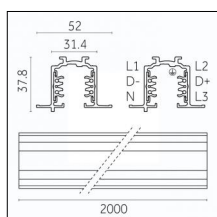

Code 0.02035.0021 - 3-circuit track recessed

Finishing: Black (Standard)
Length: 2000mm Width: 52mm Height: 37.8mm

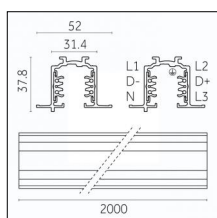

Code 0.02035.0028 - 3-circuit track recessed

Finishing: Metallised grey (Standard)
Length: 2000mm Width: 52mm Height: 37.8mm

Luminaire constructed in conformity with Directives 2014/35/EU (LV), 2014/30/EU (EMC), 2009/125/EC (Ecodesign) with Regulations (EC) No 245/2009, (EU) No 347/2010 and (EU) 2015/1428 (for luminaires with fluorescent and metal halide lamps only), 2009/125/EC (Ecodesign) with Regulations (EU) No 1194/2012 and 2015/1428 (for LED luminaires only), 2011/65/EU (RoHS 2) and 2012/19/EU (WEEE).

Tracks/channels

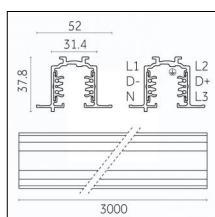
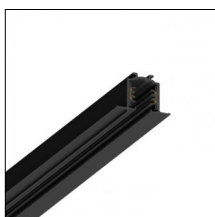

Code 0.02036.0010 - 3-circuit track recessed

Finishing: White (Standard)
Length: 3000mm Width: 52mm Height: 37.8mm

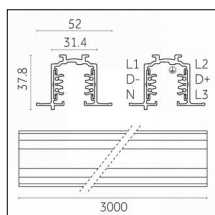
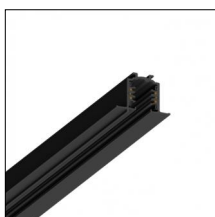

Code 0.02036.0021 - 3-circuit track recessed

Finishing: Black (Standard)
Length: 3000mm Width: 52mm Height: 37.8mm

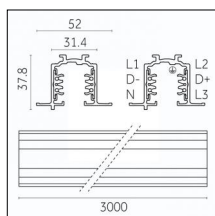

Code 0.02036.0028 - 3-circuit track recessed

Finishing: Metallised grey (Standard)
Length: 3000mm Width: 52mm Height: 37.8mm

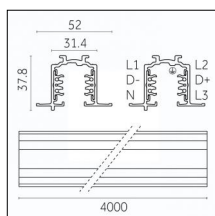

Code 0.02037.0010 - 3-circuit track recessed

Finishing: White (Standard)
Length: 4000mm Width: 52mm Height: 37.8mm

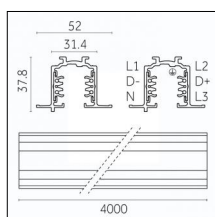

Code 0.02037.0021 - 3-circuit track recessed

Finishing: Black (Standard)
Length: 4000mm Width: 52mm Height: 37.8mm

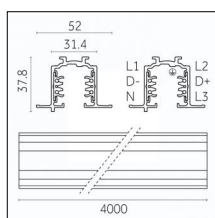

Code 0.02037.0028 - 3-circuit track recessed

Finishing: Metallised grey (Standard)
Length: 4000mm Width: 52mm Height: 37.8mm

Luminaire constructed in conformity with Directives 2014/35/EU (LV), 2014/30/EU (EMC), 2009/125/EC (Ecodesign) with Regulations (EC) No 245/2009, (EU) No 347/2010 and (EU) 2015/1428 (for luminaires with fluorescent and metal halide lamps only), 2009/125/EC (Ecodesign) with Regulations (EU) No 1194/2012 and 2015/1428 (for LED luminaires only), 2011/65/EU (RoHS 2) and 2012/19/EU (WEEE).

Tracks/channels

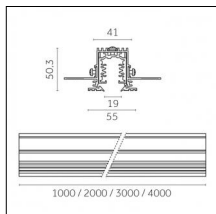

Code 0.27101.0021 - 3-circuit track Supertrack

Finishing: Black (Standard)
Length: 1000mm Width: 41mm Height: 50mm

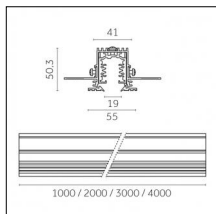

Code 0.27102.0021 - 3-circuit track Supertrack

Finishing: Black (Standard)
Length: 2000mm Width: 41mm Height: 50mm

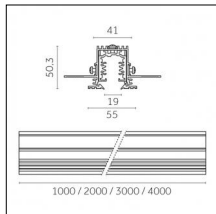

Code 0.27103.0021 - 3-circuit track Supertrack

Finishing: Black (Standard)
Length: 3000mm Width: 41mm Height: 50mm

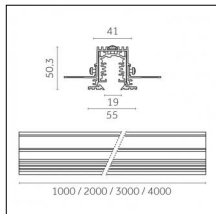

Code 0.27104.0021 - 3-circuit track Supertrack

Finishing: Black (Standard)
Length: 4000mm Width: 41mm Height: 50mm

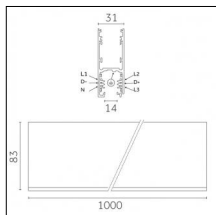

Code 0.02505.0010 - H Track | Surface/Pendant

Finishing: White (Standard)
Length: 1000mm Width: 31mm Height: 83mm

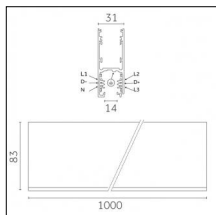

Code 0.02505.0021 - H Track | Surface/Pendant

Finishing: Black (Standard)
Length: 1000mm Width: 31mm Height: 83mm

Luminaire constructed in conformity with Directives 2014/35/EU (LV), 2014/30/EU (EMC), 2009/125/EC (Ecodesign) with Regulations (EC) No 245/2009, (EU) No 347/2010 and (EU) 2015/1428 (for luminaires with fluorescent and metal halide lamps only), 2009/125/EC (Ecodesign) with Regulations (EU) No 1194/2012 and 2015/1428 (for LED luminaires only), 2011/65/EU (RoHS 2) and 2012/19/EU (WEEE).

Tracks/channels

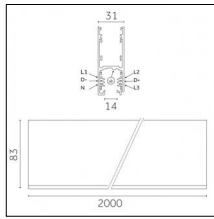
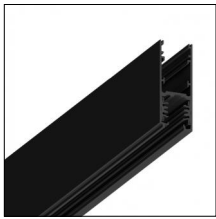

Code 0.02506.0010 - H Track | Surface/Pendant

Finishing: White (Standard)
Length: 2000mm Width: 31mm Height: 83mm

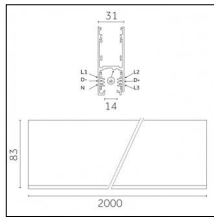

Code 0.02506.0021 - H Track | Surface/Pendant

Finishing: Black (Standard)
Length: 2000mm Width: 31mm Height: 83mm

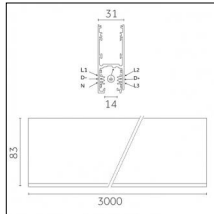
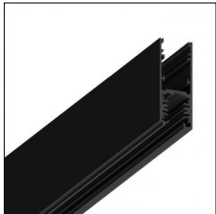

Code 0.02507.0010 - H Track | Surface/Pendant

Finishing: White (Standard)
Length: 3000mm Width: 31mm Height: 83mm

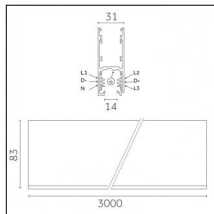

Code 0.02507.0021 - H Track | Surface/Pendant

Finishing: Black (Standard)
Length: 3000mm Width: 31mm Height: 83mm

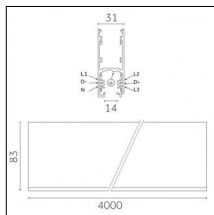
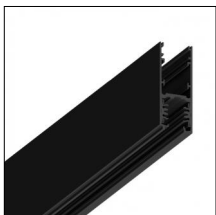

Code 0.02508.0010 - H Track | Surface/Pendant

Finishing: White (Standard)
Length: 4000mm Width: 31mm Height: 83mm

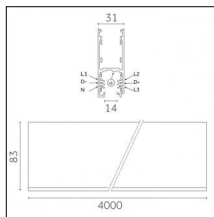

Code 0.02508.0021 - H Track | Surface/Pendant

Finishing: Black (Standard)
Length: 4000mm Width: 31mm Height: 83mm

Luminaire constructed in conformity with Directives 2014/35/EU (LV), 2014/30/EU (EMC), 2009/125/EC (Ecodesign) with Regulations (EC) No 245/2009, (EU) No 347/2010 and (EU) 2015/1428 (for luminaires with fluorescent and metal halide lamps only), 2009/125/EC (Ecodesign) with Regulations (EU) No 1194/2012 and 2015/1428 (for LED luminaires only), 2011/65/EU (RoHS 2) and 2012/19/EU (WEEE).

Optics

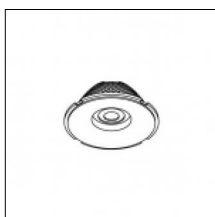

Code 0.35125.0000 - Ø60mm precision optic 12° - LED

Finishing:
Description:



Narrow 12°

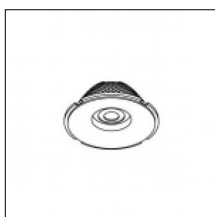

Code 0.35126.0000 - Ø60mm precision optic 20° - LED

Finishing:
Description:



Medium 20°

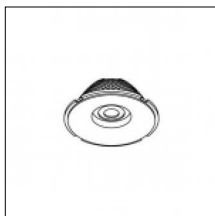

Code 0.35127.0000 - Ø60mm precision optic 32° - LED

Finishing:
Description:



Medium 32°

Accessories

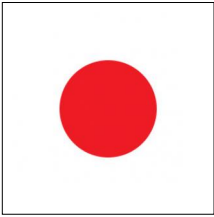

Code 0.26402.004A - Red glass filter 1 mm

Type: Optical
Finishing: Red

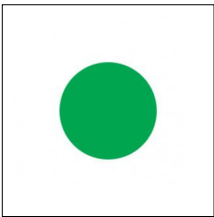

Code 0.26402.005A - Green glass filter 1 mm

Type: Optical
Finishing: Green

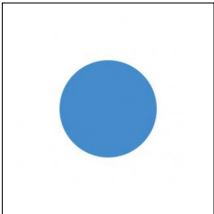

Code 0.26402.006A - Blue glass filter 1 mm

Type: Optical
Finishing: Blue

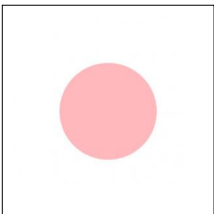

Code 0.26402.007A - Pink glass filter 1 mm

Type: Optical
Finishing: Pink

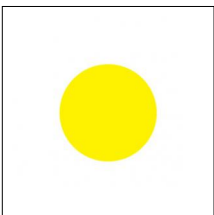

Code 0.26402.008A - Yellow glass filter 1 mm

Type: Optical
Finishing: Yellow

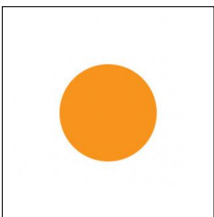

Code 0.26402.009A - Orange glass filter 1 mm

Type: Optical
Finishing: Orange

Accessories



Code 0.26410.0000 - Colored Gel Slides (2 pieces)

Type: Optical

Finishing: Without finish / Stainles Steel / Natural aluminium (Standard)

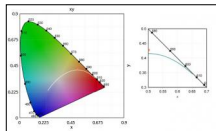
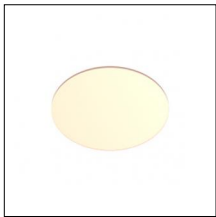

Code 0.26418.0000 - Selective filter 2700K - 2500K

Type: Optical

Finishing: Without finish / Stainles Steel / Natural aluminium (Standard)

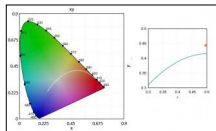
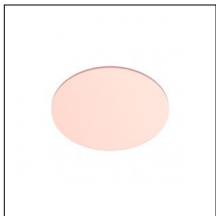

Code 0.26426.0000 - Selective filter 2700K - 2200K

Type: Optical

Finishing: Without finish / Stainles Steel / Natural aluminium (Standard)

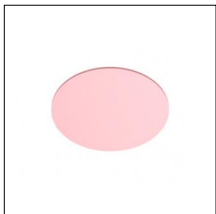

Code 0.26434.0000 - Selective filter 2700K - 2000K

Type: Optical

Finishing: Without finish / Stainles Steel / Natural aluminium (Standard)

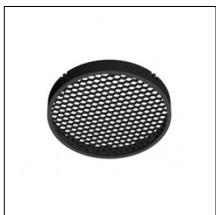

Code 0.26442.0000 - Honeycomb dense texture

Type: Optical

Finishing: Without finish / Stainles Steel / Natural aluminium (Standard)



Code 0.26450.0000 - Honeycomb wide texture

Type: Optical

Finishing: Without finish / Stainles Steel / Natural aluminium (Standard)

Accessories

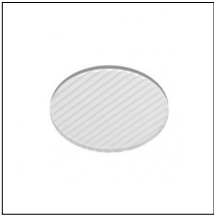

Code 0.26457.0000 - Ribbed glass

Type: Optical
Finishing: Without finish / Stainles Steel / Natural aluminium (Standard)

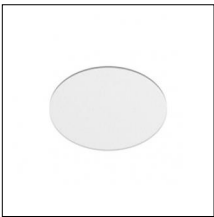

Code 0.26462.0000 - Opal lens

Type: Optical
Finishing: Without finish / Stainles Steel / Natural aluminium (Standard)

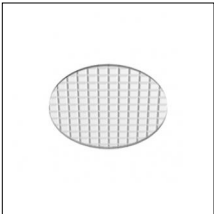

Code 0.26470.0000 - Diffusive lens

Type: Optical
Finishing: Without finish / Stainles Steel / Natural aluminium (Standard)

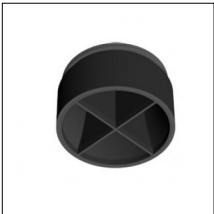

Code 0.26477.0000 - Cross blade louvre

Type: Optical
Finishing: Without finish / Stainles Steel / Natural aluminium (Standard)

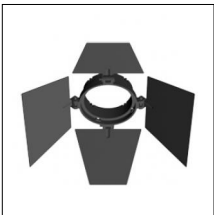

Code 0.26485.0000 - Barn doors

Type: Optical
Finishing: Without finish / Stainles Steel / Natural aluminium (Standard)

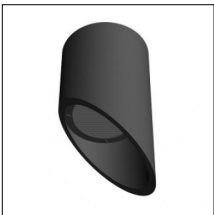

Code 0.26489.0012 - Cone 45 ° wall washer

Type: Optical
Finishing: Embossed matt white (Standard)

Accessories

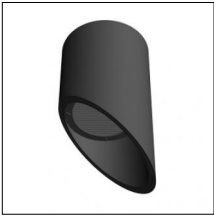

Code 0.26489.0031 - Cone 45 ° wall washer

Type: Optical
Finishing: Embossed matt black (Standard)

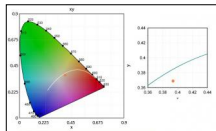
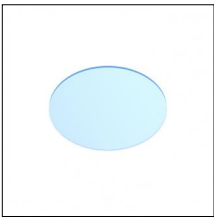

Code 0.26567.0000 - Selective filter 3000K-3600K

Type: Optical
Finishing: Without finish / Stainles Steel / Natural aluminium (Standard)

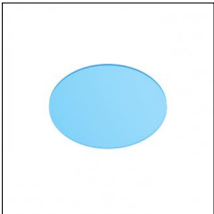

Code 0.26575.0000 - Selective filter 3000K-4000K

Type: Optical
Finishing: Without finish / Stainles Steel / Natural aluminium (Standard)

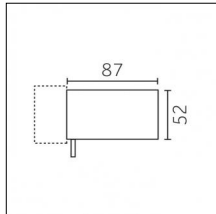

Code 0.26650.0021 - Framing accessory, light shape - round

Type: Optical
Finishing: Black (Standard)

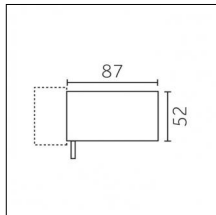

Code 0.26651.0021 - Framing accessory, light shape - square

Type: Optical
Finishing: Black (Standard)