











Made in Italy

 Pasito Mini 1.0, code: PM1010000050AF
Step lights for outdoor applications

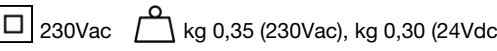
14/04/2025 Rev. 07/2024

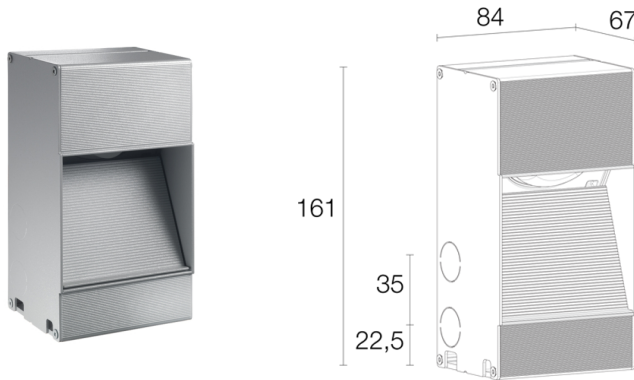

DESCRIPTION

step light for outdoor applications; recessed, flush (wall); Power consumption: 6W; Power supply: 230Vac; Lumen output at source: 383 lm (3000K, CRI 80); Delivered lumen output: 214 lm (3000K, 150°x90° asymmetrical, CRI 80, white finish); 1 power LED High Intensity, 1/4 ANSI BIN, 50 000h L90 B10 (Ta 25°C); LED colour: 3000K; Optics: asymmetrical 150°x90°: optical system consisting of an asymmetrical hemispherical lens, installed at an angle and set back in the chamber to create a controlled downward light beam, reducing light spill to a minimum; Upward flux fraction: 15,83% (asymmetrical 150°x90°, white, grey finish), 1,65% (asymmetrical 150°x90°, cor-ten, anthracite finish), 11,25% (60°, white, grey finish), 3,59% (60°, cor-ten, anthracite finish); CRI Colour Rendering Index: 80; Body material: body made of ANTICORODAL 6060 low-copper-content aluminium alloy, made from an extruded profile, then anodized black to give the product better heat dissipation and increase its resistance to corrosion. Structured reflector made of extruded ANTICORODAL 6060 aluminium, painted in the same colour; Finishes: grey finish obtained through an initial treatment with a ceramic nanoparticle coating, to prepare for painting, followed by a coat of epoxy paint and one of polyester paint to provide corrosion resistance of more than 1500 hours of salt spray. Paints compliant with the Qualicoat standard used in the automotive sector (RAL 9006); RAL finish on request; power supply unit included; includes 0.20 m neoprene cable, H05RN-F 2x1.00 Ø7 mm; Control system: ON/OFF; Ingress protection: IP65; Impact resistance: IK05; Casambi control using the Casambi app with dedicated electronics; Protection systems: IPS (Intelligent Protection System) protects lighting fixtures from water infiltrations, which can occur if there are faulty junctions between the cables in outdoor or underwater applications. This innovation, patented by L&L, also guarantees electrical protection against polarity reversal, hot plugging, ESD and power surges, which can occur if there are faults in the electrical circuit; Operating temperature: -20°C — +45°C; Photobiological safety: photobiological safety: risk group 1 according to EN 62471:2006; Appliance class: class II; Weight: 350 g (230Vac), 300 g (24Vdc); Dimensions: 84x67x161 mm; Cutout dimensions: 86x165 mm; Energy efficiency class: F (light source) in accordance with EU 2019/2015; Accessories: WCA00F Outer casing - grey; tested and approved via E.O.L. (End Of Line) test with functioning test and check of electrical power consumption

Status: Available

ELECTRICAL CHARACTERISTICS

Power consumption	6W
Power supply	230Vac
Power supply unit	power supply unit included
Control system	ON/OFF

LIGHTING CHARACTERISTICS

Number and type of LED	1 power LED High Intensity
Average LED life	50 000h L90 B10 (Ta 25°C)
LED colour	3000K
CRI Colour Rendering Index	80
Binning	1/4 ANSI BIN
Optics	asymmetrical 150°x90°
Lumen output at source	383 lm (3000K, CRI 80)
Delivered lumen output	214 lm (3000K, 150°x90° asymmetrical, CRI 80, white finish)

MECHANICAL CHARACTERISTICS

Dimensions	84x67x161 mm
Weight	350 g (230Vac), 300 g (24Vdc)
Finishes	grey RAL 9006
Mounting	with outer casing
Body material	body in anticorodal aluminium
Cutout dimensions	86x165 mm

GENERAL CHARACTERISTICS

Ingress protection	IP65
Operating temperature	-20°C — +45°C
Impact resistance	IK05
Energy efficiency class	F (light source) in accordance with EU 2019/2015
Appliance class	class II
Walkover	no
Drive-over	no
Power cables	includes 0.20 m neoprene cable, H05RN-F 2x1.00 Ø7 mm
Protection systems	IPS (Intelligent Protection System)
Photobiological safety	photobiological safety: risk group 1 according to EN 62471:2006
Notes	Casambi control using the Casambi app with dedicated electronics

PHOTOMETRIC DATA

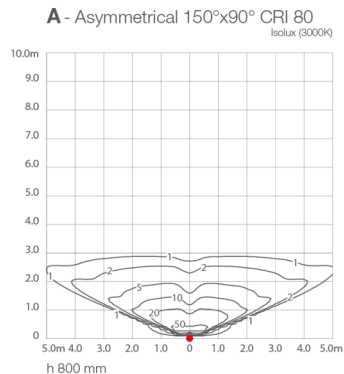
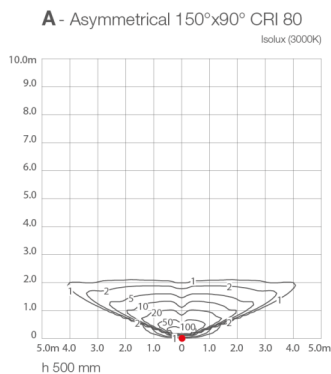

ACCESSORIES

Installation Accessories

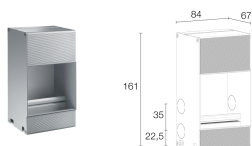

WCA00F

Outer casing - grey

Required outer casing not included

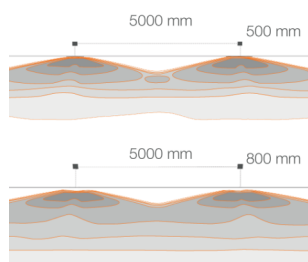

A - Asymmetrical 150°x90°

L&L Luce&Light SRL reserves the right to change the information contained in this document at any time without prior notice being given.