

## Legend

### 96262581 LEGEND 36L70 RC 740 BP CL1 T60

LED 77W LEG_36L70-740RC	ISO 9223 C5	IP65	IK08						
-------------------------	----------------	------	------	--	--	--	--	--	--

#### Legend

A modern heritage post top LED lantern with closed optic. Electronic, Class I electrical, IP65, IK08. Body: Die-cast aluminium powder coated grey 900 textured finish (close to RAL 7043). Enclosure: flat toughened glass. Surge protection: 10kV single pulse common mode and 8kV multipulse common mode and 6kV multipulse differential mode. If permanent DALI system is connected, 6kV multipulse common and differential mode. Complete with 4000K LED.

Dimensions: 446 x 446 x 999 mm  
 Luminaire input power: 77 W  
 Weight: 17.5 kg  
 Scx: 0.14 m<sup>2</sup>



TLG\_LGND\_F\_CLS.jpg

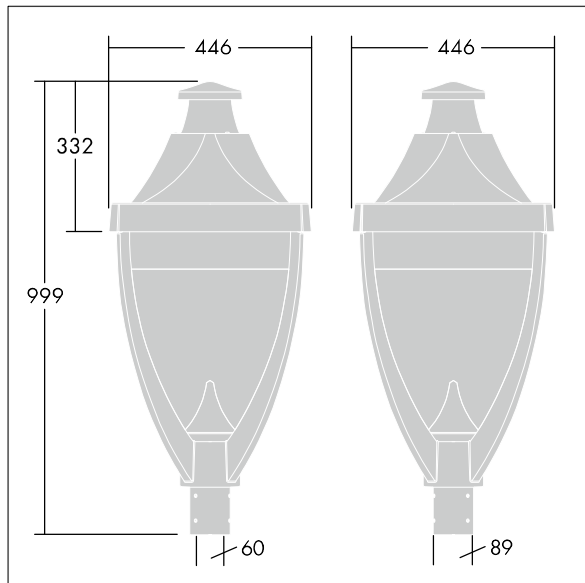

TLG\_LGND\_M\_MTP.wmf

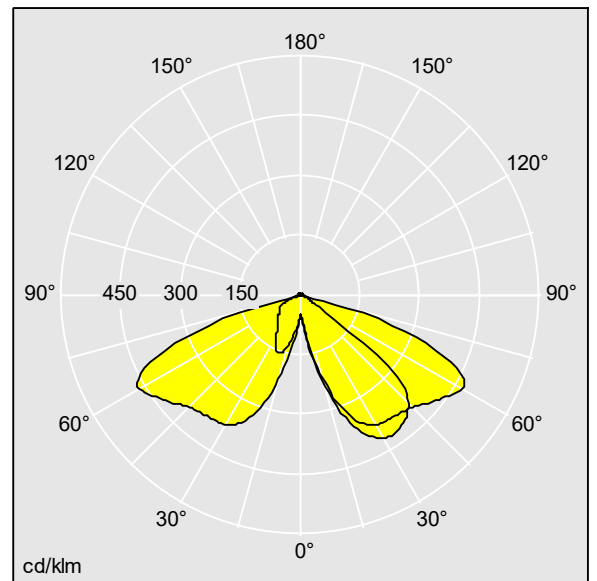

TL\_LE36L70RC740.ltd

Lamp position: STD - standard  
 Light Source: LED  
 Luminaire luminous flux\*: 9787 lm  
 Luminaire efficacy\*: 127 lm/W  
 Colour Rendering Index min.: 70  
 LOR: 1,00 ULOR: 0,02 DLOR: 0,99

Correlated colour temperature\*: 4000 Kelvin  
 Chromaticity tolerance (initial MacAdam): 5  
 Rated useful life (B10)\*:  
 L90 100000 h at 25 °C  
 Ballast: 1x EL2 Tridonic  
 Luminaire input power\*: 77 W Power factor = 0.97

This product contains a light source of energy efficiency class D.

All values marked with an \* are rated values. Thorn uses tried and tested components from leading suppliers, however there may be isolated instances of technology-related failures of individual LEDs during the rated product lifetime. International standards set the tolerance in initial flux and connected load at ±10%. Unless stated otherwise, the values apply to an ambient temperature of 25°C. Risk group