

Made in Italy

 Flori 1.0, code: FS101005LH
Projectors for outdoor applications

14/04/2025 Rev. 09/2024

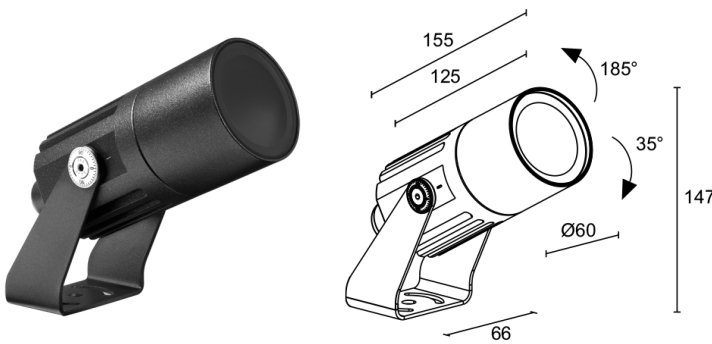
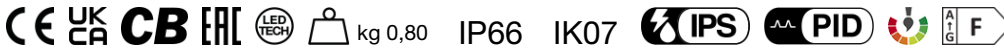

DESCRIPTION

projector for outdoor applications; surface mounted (ceiling, wall, ground, spike, strap); Power consumption: 7W; Power supply: 230Vac; Lumen output at source: 657 lm (3000K, CRI 80); Delivered lumen output: 366 lm (3000K, 31°, CRI 80); 1 power LED High Intensity, 3-step MacAdam, 50 000h L90 B10 (Ta 25°C); LED colour: 3000K; Optics: 36°; CRI Colour Rendering Index: 80; Body material: body in aluminium; Finishes: anthracite; RAL finish on request; Screen material: screen in serigraphed, transparent and tempered extra-clear glass; built-in power supply unit; includes 1.5 m neoprene cable H05RN-F 3x1,0 Ø7 mm; Ingress protection: IP66; Impact resistance: IK07; version with 24Vdc power supply available on request; Protection systems: IPS (Intelligent Protection System) protects lighting fixtures from water infiltrations, which can occur if there are faulty junctions between the cables in outdoor or underwater applications. This innovation, patented by L&L, also guarantees electrical protection against polarity reversal, hot plugging, ESD and power surges, which can occur if there are faults in the electrical circuit; The PID (Protective Impedance Device) protects lighting fixtures from electrical phenomena external to the system, such as static electricity accumulation or electromagnetic interference coming from the mains power. Generally, these are events with a low energy content; Operating temperature: -20°C — +45°C; Glow wire test: 960°C; Photobiological safety: photobiological safety: risk group 1 according to EN 62471:2006; Appliance class: class I; Weight: 800 g; Dimensions: Ø60x154x147 mm; Energy efficiency class: F (light source) in accordance with EU 2019/2015; Accessories: WB1001H Standard with snoot - anthracite, WB1002H Asymmetrical snoot - anthracite, WB1003N Barn doors - black, WHA0005 Honeycomb louvre , WP0100 Spike for in-ground installation, WP1001H Spike with bracket for in-ground installation - h 500 mm - anthracite, WP1002H Spike with bracket for in-ground installation - h 800 mm - anthracite, WP1003H Arm with bracket for wall-mounted installation - h 420 mm - anthracite, WP1004 Fastener strap - 5 m; tested and approved via E.O.L. (End Of Line) test with functioning test and check of electrical power consumption

Status: Available

ELECTRICAL CHARACTERISTICS

Power consumption	7W
Power supply	230Vac
Power supply unit	built-in power supply unit

LIGHTING CHARACTERISTICS

Number and type of LED	1 power LED High Intensity
Average LED life	50 000h L90 B10 (Ta 25°C)
LED colour	3000K
CRI Colour Rendering Index	80
Binning	3-step MacAdam
Optics	36°
Lumen output at source	657 lm (3000K, CRI 80)
Delivered lumen output	366 lm (3000K, 31°, CRI 80)

MECHANICAL CHARACTERISTICS

Dimensions	Ø60x154x147 mm
Weight	800 g
Finishes	anthracite
Mounting	with bracket, screws and plugs
Body material	body in aluminium
Screen material	screen in serigraphed, transparent, tempered extra-clear glass

GENERAL CHARACTERISTICS

Ingress protection	IP66
Operating temperature	-20°C — +45°C
Impact resistance	IK07
Energy efficiency class	F (light source) in accordance with EU 2019/2015
Glow wire test	960°C
Appliance class	class I
Walkover	no
Drive-over	no
Power cables	includes 1.5 m neoprene cable H05RN-F 3x1,0 Ø7 mm
Protection systems	IPS (Intelligent Protection System); PID (Protective Impedance Device)
Photobiological safety	photobiological safety: risk group 1 according to EN 62471:2006
Notes	version with 24Vdc power supply available on request

PHOTOMETRIC DATA

L - 36° CRI 80

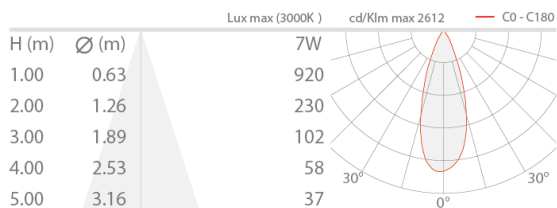

ACCESSORIES

Installation Accessories



WP0100
Spike for in-ground installation

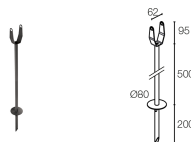

WP1001H
Spike with bracket for in-ground installation - h 500 mm - anthracite

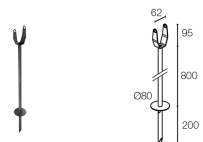

WP1002H
Spike with bracket for in-ground installation - h 800 mm - anthracite



WP1003H
Arm with bracket for wall-mounted installation - h 420 mm - anthracite

Anti-glare



WB1001H
Standard snoot - anthracite

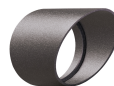

WB1002H
Asymmetrical snoot - anthracite

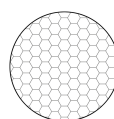

WB1003N

Barn doors - black

WHA0005Honeycomb louvre
built into the lighting fixture

Order together with the lighting fixture

Other**WP1004**

Fastener strap - 5 m

L&L Luce&Light SRL reserves the right to change the information contained in this document at any time without prior notice being given.