









Made in Italy

 Ella OUT 2.0, code: EA20105DHT
Wall mounted for outdoor applications



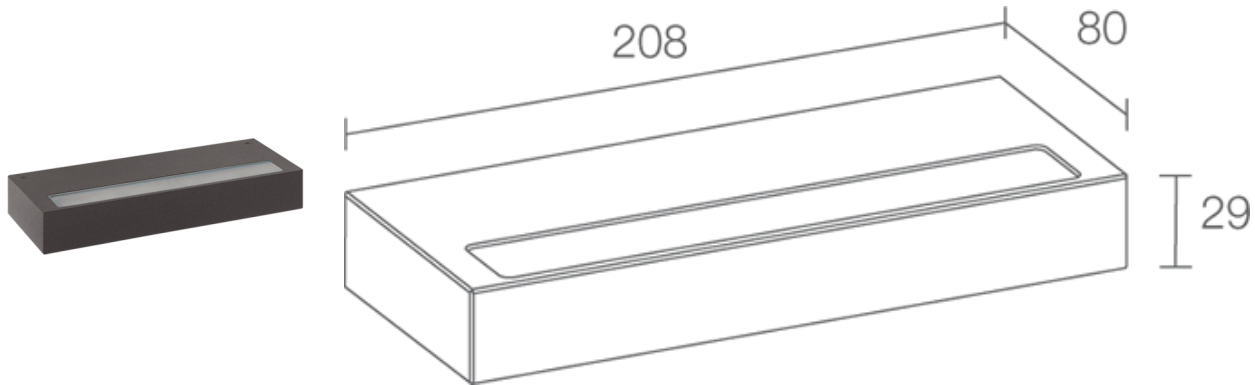

 kg 0,80
 



14/04/2025 Rev. 10/2024



DESCRIPTION

wall mounted for outdoor applications; surface mounted (wall); Power consumption: 16W; Power supply: 230Vac; Lumen output at source: 1908 lm (3000K); Delivered lumen output: 985 lm (3000K); 36 mid-power LEDs, 3-step MacAdam, 50 000h L80 B10 (Ta 25°C); LED colour: 3000K; Optics: diffuse; CRI Colour Rendering Index: 80; Body material: body in anticorodal aluminium; Finishes: anthracite; RAL finish on request; Screen material: screen in serigraphed extra-clear microprismatic glass; built-in power supply unit; includes 1.5 m neoprene cable H05RN-F 3x1,0 Ø7 mm; Ingress protection: IP65; Impact resistance: IK08; Operating temperature: -20°C — +45°C; Glow wire test: 960°C; Photobiological safety: photobiological safety: risk group 1 according to EN 62471:2006; Appliance class: class I; Weight: 800 g; Dimensions: 208x80x29 mm; Energy efficiency class: F (light source) in accordance with EU 2019/2015; Accessories: WD0652H Spacer - anthracite; tested and approved via E.O.L. (End Of Line) test with functioning test and check of electrical power consumption

Status: Available

ELECTRICAL CHARACTERISTICS

Power consumption	16W
Power supply	230Vac
Power supply unit	built-in power supply unit

LIGHTING CHARACTERISTICS

Number and type of LED	36 mid-power LEDs
Average LED life	50 000h L80 B10 (Ta 25°C)
LED colour	3000K
CRI Colour Rendering Index	80
Binning	3-step MacAdam
Optics	diffuse
Lumen output at source	1908 lm (3000K)
Delivered lumen output	985 lm (3000K)

MECHANICAL CHARACTERISTICS

Dimensions	208x80x29 mm
Weight	800 g
Finishes	anthracite
Mounting	with mounting plate, screws and plugs
Body material	body in anticorodal aluminium
Screen material	screen in serigraphed extra-clear microprismatic glass

GENERAL CHARACTERISTICS

Ingress protection	IP65
Operating temperature	-20°C — +45°C
Impact resistance	IK08
Energy efficiency class	F (light source) in accordance with EU 2019/2015
Glow wire test	960°C
Appliance class	class I
Walkover	no
Drive-over	no
Power cables	includes 1.5 m neoprene cable H05RN-F 3x1,0 Ø7 mm
Photobiological safety	photobiological safety: risk group 1 according to EN 62471:2006

PHOTOMETRIC DATA

D – Diffuse



ACCESSORIES

Installation Accessories



WD0652H

Spacer - anthracite

L&L Luce&Light SRL reserves the right to change the information contained in this document at any time without prior notice being given.