

Mood Fixed Round M (Phase Out)

| | Mood Fixed Round

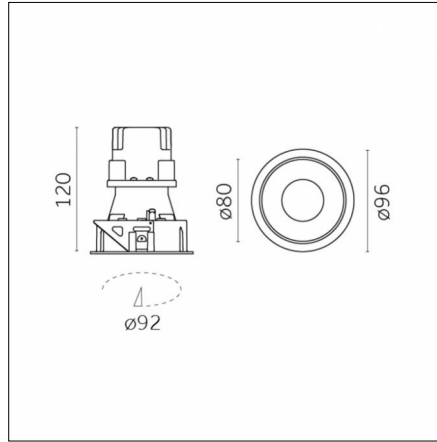

**CUT
OUT**

92mm



Medium-wide 39°

12

IP20
IP44



Risk 1

850°



Code X.BG12H.HQ12

Light source features

Number of light sources: 1

Source type: LED HQ

Watt: 8.5W

Lm: 836lm

Lm/W: 98lm/W

Kelvin/CRI: 3000 / >90

SDCM/L90 B10: < 2 / 50000

Fixture total output: 336 lm

Fixture efficacy: 36 lm/W

Imax: 846 cd

Electrical features

Driver included: NO

Driver position: remote

Driver type: no driver included 220/240 Vac 50/60 Hz*

Total power consumption (LED + DRIVER): 10W

Isolation class: Class III

Optical features

Beam angle: 39°

Optical type, adjustability: Fixed

Interchangeable optic (IOS): NO

Physical features

Material: aluminum

Mounting: Recessed

Fixing: Ceiling

Finishing: Embossed matte white

Weight: 0.275Kg

Notes:

*700mA

Luminaire constructed in conformity with Directives 2014/35/EU (LV), 2014/30/EU (EMC), 2009/125/EC (Ecodesign) with Regulations (EC) No 245/2009, (EU) No 347/2010 and (EU) 2015/1428 (for luminaires with fluorescent and metal halide lamps only), 2009/125/EC (Ecodesign) with Regulations (EU) No 1194/2012 and 2015/1428 (for LED luminaires only), 2011/65/EU (RoHS 2) and 2012/19/EU (WEEE).

Reggiani Lighting Srl

Viale Monza, 16 20845 Sovico (MB) Italy
Tel. (+39) 039 2071.1 fax (+39) 039 2071 999

www.reggiani.net
contact@reggiani.net

Photometries

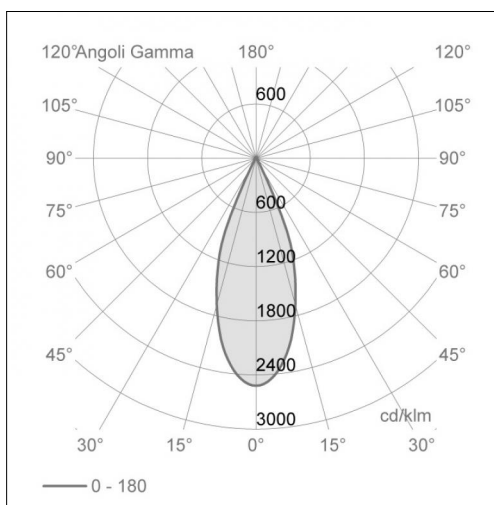
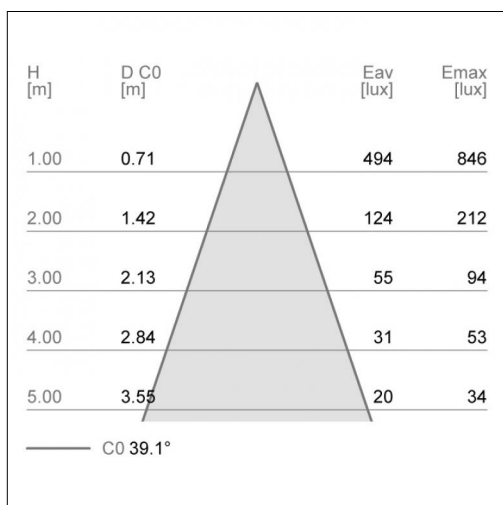

X_BG12H_HQ_12.ies

X_BG12H_HQ_12.LDT

Driver

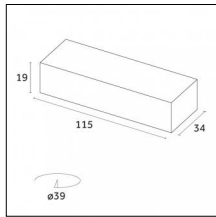

Code 0.30419.0000 - Driver

Type: On-Off

Watt: 12W - AC Input: 120-240V - mA:700mA

Description: For more details, see the driver datasheet.

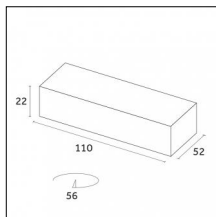

Code D.30420.0000 - Driver DALI (Bluetooth with Casambi accessory 0.26101.0000)

Type: DALI

Watt: W - AC Input: 220-240Vac - mA:700mA

Description: For more details, see the driver datasheet.

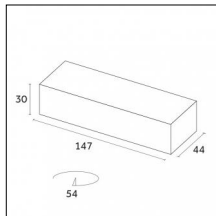

Code D.30421.0000 - Driver DALI (Bluetooth with Casambi accessory 0.26101.00)

Type: DALI

Watt: 38W - AC Input: 220-240Vac - mA:700mA

Description: For more details, see the driver datasheet.

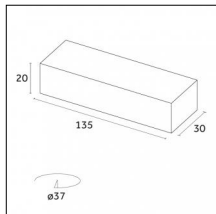

Code T.30420.0000 - Driver Mood

Type: PHASE CUT

Watt: 10W - AC Input: 220-240Vac - mA:700mA

Description: For more details, see the driver datasheet.

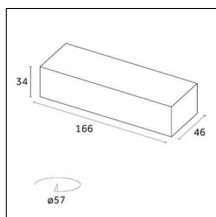

Code T.30421.0000 - Driver

Type: PHASE CUT

Watt: 32W - AC Input: 220-240Vac - mA:700mA

Description: For more details, see the driver datasheet.

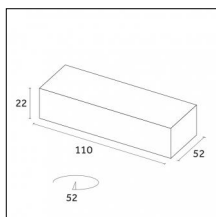

Code V.30420.0000 - Driver

Type: 1-10V

Watt: 20W - AC Input: 220-240Vac - mA:700mA

Description: For more details, see the driver datasheet.

Driver

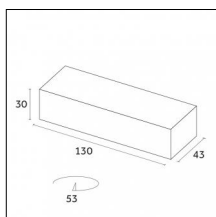

Code V.30421.0000 - Driver

Type: 1-10V

Watt: W - AC Input: 220-240Vac - mA:700mA

Description: For more details, see the driver datasheet.

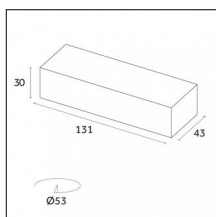

Code 0.30041.0000 - Driver On-Off

Type: On-Off

Watt: 36W - AC Input: 220-240Vac - mA:700mA

Description: For more details, see the driver datasheet.

Accessories

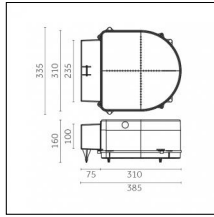

Code 0.40194.0000 - Formwork

Type: Mounting

Finishing: Without finish / Natural aluminium

Length: 385mm Width: 335mm Height: 160mm

Description: To install in reinforced concrete and masonry